

External view

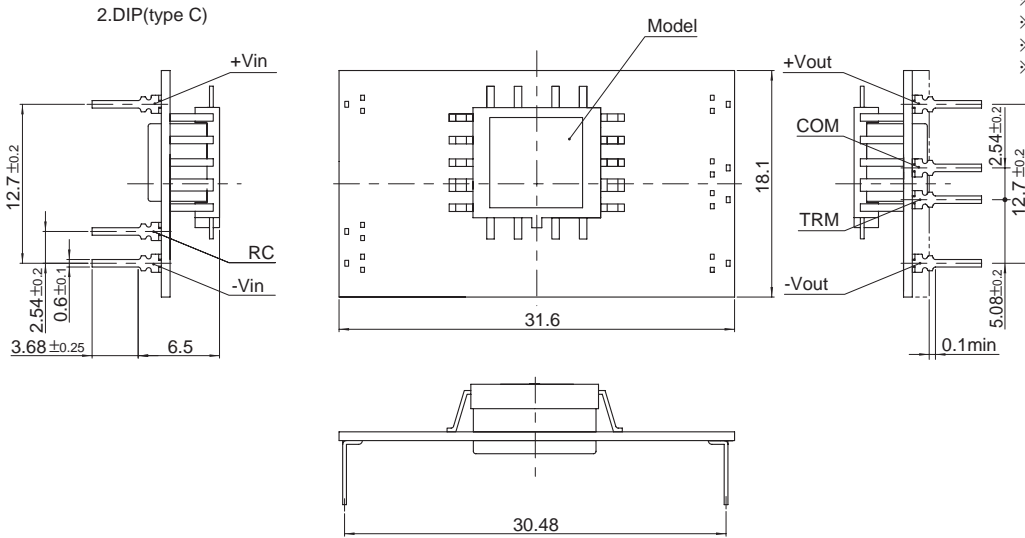
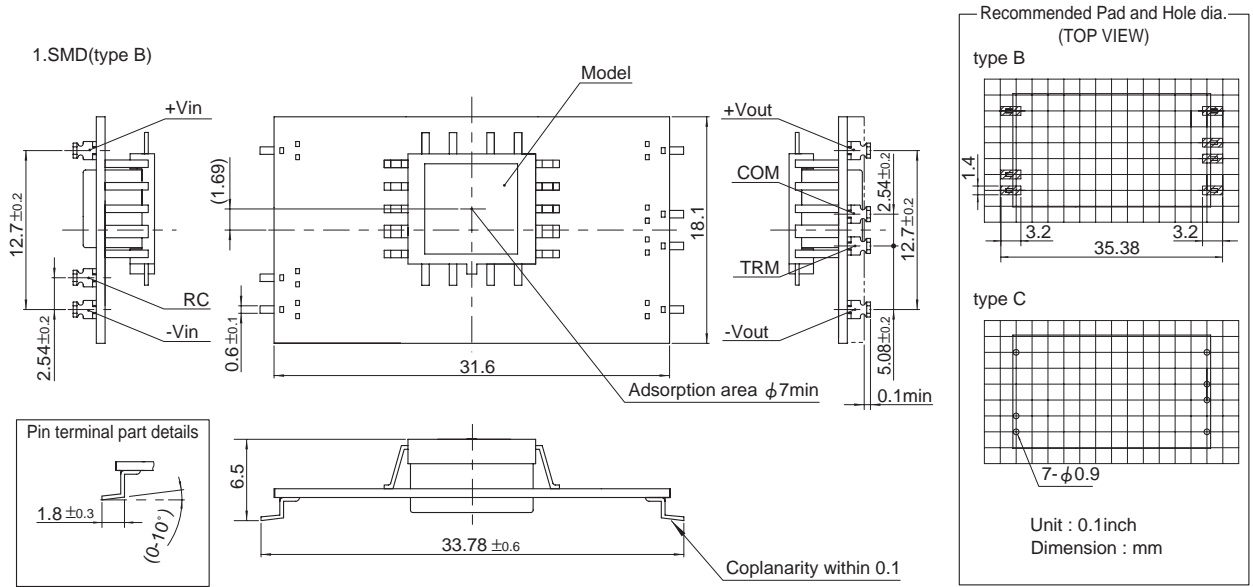

- ※ Tolerance ±0.5
- ※ Dimensions in mm
- ※ Pin terminal thickness : 0.3±0.1
- ※ Pin terminal material : Copper alloy
- ※ Plating treatment of terminal : Lead free plating
- ※ Mass 4g less