



## FEATURES

- 30 WATTS MAXIMUM OUTPUT POWER
- OUTPUT CURRENT UP TO 6A
- STANDARD 2.0 X 1.6 X 0.4 INCH PACKAGE
- HIGH EFFICIENCY UP TO 90%
- 2:1 WIDE INPUT VOLTAGE RANGE
- SIX-SIDED CONTINUOUS SHIELD
- FIXED SWITCHING FREQUENCY
- OFFER SINGLE AND DUAL OUTPUT
- CE MARK MEETS 2006/95/EC, 93/68/EEC AND 2004/108/EC
- UL60950-1, EN60950-1 AND IEC60950-1 LICENSED
- ISO9001 CERTIFIED MANUFACTURING FACILITIES
- COMPLIANT TO RoHS EU DIRECTIVE 2002/95/EC

## APPLICATIONS

Wireless Network  
Telecom/Datacom  
Industry Control System  
Measurement Equipment  
Semiconductor Equipment

## DESCRIPTION

The FEC30 series offer 30 Watts of output power from a 2.0 x 1.6 x 0.4 inch package. The FEC30 series with 2:1 wide input voltage of 9-18VDC, 18-36VDC and 36-75VDC and features 1600VDC of isolation, short-circuit and over-voltage protection.

## TECHNICAL SPECIFICATION

All specifications are typical at nominal input, full load and 25°C otherwise noted

OUTPUT SPECIFICATIONS			
Output power	30 Watts max.		
Voltage accuracy	Full load and nominal Vin	Single/Dual	± 1%
Minimum load	0%		
Voltage adjustability	± 10%		
Line regulation	LL to HL at Full Load	Single Dual	± 0.2% ± 0.5%
Load regulation	No Load to Full Load	Single Dual	± 0.5% ± 1%
Cross regulation (Dual)	Asymmetrical load 25% / 100% FL		± 5%
Ripple and noise	20MHz bandwidth (Measured with a 0.1µF/50V MLCC)		See table
Temperature coefficient	±0.02% / °C, max.		
Transient response recovery time	25% load step change	300µS	
Over voltage protection Zener diode clamp	1.5V output	3.9V	
	1.8V output	3.9V	
	2.5V output	3.9V	
	3.3V output	3.9V	
	5V output	6.2V	
	12V output 15V output	15V 18V	
Over load protection	% of FL at nominal input	150%,max.	
Short circuit protection	Hiccup, automatics recovery		
GENERAL SPECIFICATIONS			
Efficiency	See table		
Isolation voltage	Input to Output Input (Output) to Case	1600VDC, min.	
Isolation resistance	10 <sup>9</sup> ohms, min.		
Isolation capacitance	1000pF, max.		
Switching frequency	300KHz, typ.		
Approvals and standard	IEC60950-1, UL60950-1, EN60950-1		
Case material	Nickel-coated copper		
Base material	FR4 PCB		
Potting material	Epoxy (UL94-V0)		
Dimensions	2.00 X 1.60 X 0.40 Inch (50.8 X 40.6 X 10.2 mm)		
Weight	48g (1.69oz)		
MTBF (Note 1)	BELLCORE TR-NWT-000332	1.316 x 10 <sup>6</sup> hrs	
	MIL-HDBK-217F	3.465 x 10 <sup>5</sup> hrs	

INPUT SPECIFICATIONS			
Input voltage range	12V nominal input	9 – 18VDC	
	24V nominal input	18 – 36VDC	
	48V nominal input	36 – 75VDC	
Input filter	L-C type		
Input surge voltage 100mS max.	12V input	36VDC	
	24V input	50VDC	
	48V input	100VDC	
Input reflected ripple current	Nominal Vin and full load	30mA <sub>p-p</sub>	
Start up time	Nominal Vin and constant resistive load	Power up	25mS, typ
		Remote ON/OFF	25mS, typ
Start-up voltage	12V input	9VDC	
	24V input	17.8VDC	
	48V input	36VDC	
Shutdown voltage	12V input	8VDC	
	24V input	16VDC	
	48V input	33VDC	
Remote ON/OFF (Note 6) (Positive logic)	DC-DC ON	Open or 3.0V < Vr < 12V	
	DC-DC OFF	Short or 0V < Vr < 1.2V	
Input current of remote control pin	Nominal Vin	-0.5mA ~ 0.5mA	
Remote off state input current	Nominal Vin	2.5mA	
ENVIRONMENTAL SPECIFICATIONS			
Operating ambient temperature	-40°C ~ +85°C (with derating)		
Maximum case temperature	100°C		
Storage temperature range	-55°C ~ +105°C		
Over temperature protection	115°C, typ		
Thermal impedance (Note 7)	Nature convection	10°C/Watt	
	Nature convection with heat-sink	8.24°C/Watt	
Thermal shock	MIL-STD-810F		
Vibration	MIL-STD-810F		
Relative humidity	5% to 95% RH		
EMC CHARACTERISTICS			
EMI (Note 8)	EN55022	Class A	
ESD	EN61000-4-2	Air ± 8KV	Perf. Criteria B
		Contact ± 6KV	
Radiated immunity	EN61000-4-3	10 V/m	Perf. Criteria A
Fast transient (Note 9)	EN61000-4-4	± 2KV	Perf. Criteria B
Surge (Note 9)	EN61000-4-5	± 1KV	Perf. Criteria B
Conducted immunity	EN61000-4-6	10 Vr.m.s	Perf. Criteria A



Model Number	Input Range	Output Voltage	Output Current		Output (4) Ripple & Noise	Input Current		Eff (4) (%)	Capacitor (5) Load max.
			Min. load	Full load		No load (3)	Full load(2)		
FEC30-12S1P5	9 – 18 VDC	1.5 VDC	0mA	6000mA	50mVp-p	100mA	1014mA	78	85800μF
FEC30-12S1P8	9 – 18 VDC	1.8 VDC	0mA	6000mA	50mVp-p	100mA	1169mA	81	65000μF
FEC30-12S2P5	9 – 18 VDC	2.5 VDC	0mA	6000mA	50mVp-p	110mA	1582mA	83	33000μF
FEC30-12S3P3	9 – 18 VDC	3.3 VDC	0mA	6000mA	50mVp-p	115mA	2037mA	85	19500μF
FEC30-12S05	9 – 18 VDC	5 VDC	0mA	6000mA	50mVp-p	95mA	3012mA	87	10200μF
FEC30-12S12	9 – 18 VDC	12 VDC	0mA	2500mA	75mVp-p	170mA	2976mA	88	3240μF
FEC30-12S15	9 – 18 VDC	15 VDC	0mA	2000mA	75mVp-p	210mA	2976mA	88	1100μF
FEC30-12D12	9 – 18 VDC	±12 VDC	0mA	±1250mA	100mVp-p	60mA	3012mA	87	±1020μF
FEC30-12D15	9 – 18 VDC	±15 VDC	0mA	±1000mA	100mVp-p	40mA	3012mA	87	±675μF
FEC30-24S1P5	18 – 36 VDC	1.5 VDC	0mA	6000mA	50mVp-p	50mA	493mA	80	85800μF
FEC30-24S1P8	18 – 36 VDC	1.8 VDC	0mA	6000mA	50mVp-p	35mA	580mA	82	65000μF
FEC30-24S2P5	18 – 36 VDC	2.5 VDC	0mA	6000mA	50mVp-p	45mA	780mA	84	33000μF
FEC30-24S3P3	18 – 36 VDC	3.3 VDC	0mA	6000mA	50mVp-p	50mA	1010mA	86	19500μF
FEC30-24S05	18 – 36 VDC	5 VDC	0mA	6000mA	50mVp-p	50mA	1490mA	88	10200μF
FEC30-24S12	18 – 36 VDC	12 VDC	0mA	2500mA	75mVp-p	80mA	1470mA	89	3300μF
FEC30-24S15	18 – 36 VDC	15 VDC	0mA	2000mA	75mVp-p	90mA	1470mA	89	1100μF
FEC30-24D12	18 – 36 VDC	±12 VDC	0mA	±1250mA	100mVp-p	30mA	1488mA	88	±1020μF
FEC30-24D15	18 – 36 VDC	±15 VDC	0mA	±1000mA	100mVp-p	30mA	1488mA	88	±675μF
FEC30-48S1P5	36 – 75 VDC	1.5 VDC	0mA	6000mA	50mVp-p	20mA	244mA	81	85800μF
FEC30-48S1P8	36 – 75 VDC	1.8 VDC	0mA	6000mA	50mVp-p	20mA	290mA	83	65000μF
FEC30-48S2P5	36 – 75 VDC	2.5 VDC	0mA	6000mA	50mVp-p	25mA	390mA	85	33000μF
FEC30-48S3P3	36 – 75 VDC	3.3 VDC	0mA	6000mA	50mVp-p	30mA	500mA	87	19500μF
FEC30-48S05	36 – 75 VDC	5 VDC	0mA	6000mA	50mVp-p	35mA	740mA	89	10200μF
FEC30-48S12	36 – 75 VDC	12 VDC	0mA	2500mA	75mVp-p	35mA	730mA	90	3300μF
FEC30-48S15	36 – 75 VDC	15 VDC	0mA	2000mA	75mVp-p	55mA	730mA	90	1100μF
FEC30-48D12	36 – 75 VDC	±12 VDC	0mA	±1250mA	100mVp-p	20mA	744mA	88	±1020μF
FEC30-48D15	36 – 75 VDC	±15 VDC	0mA	±1000mA	100mVp-p	20mA	744mA	88	±675μF

**Note**

- BELLCORE TR-NWT-000332. Case 1: 50% Stress, Temperature at 40°C.  
MIL-HDBK-217F Notice2 @Ta=25 °C, Full load(Ground, Benign, controlled environment).
- Maximum value at nominal input voltage and full load.
- Typical value at nominal input voltage and no load.
- Typical value at nominal input voltage and full load.
- Test by minimum Vin and constant resistive load.
- The ON/OFF control pin voltage is referenced to -Vin.
- Heat sink is optional and P/N: 7G-0011C-F.
- The FEC30 series can meet EN55022 Class A with parallel an external capacitor to the input pins.  
Recommend: 12Vin : 6.8μF/50V 1812 MLCC .  
24Vin : 6.8μF/50V 1812 MLCC .  
48Vin : 2.2μF/100V 1812 MLCC.
- An external input filter capacitor is required if the module has to meet EN61000-4-4, EN61000-4-5.  
The filter capacitor Power Mate suggest: Nippon chemi-con KY series, 220 μ F/100V, ESR 48m Ω.

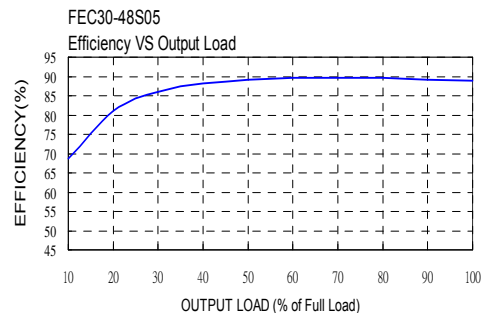
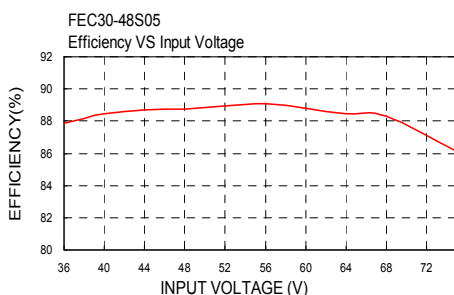
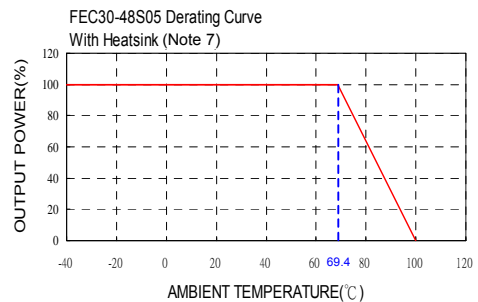
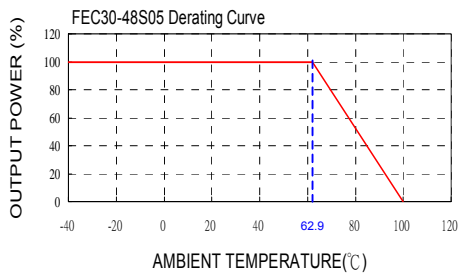

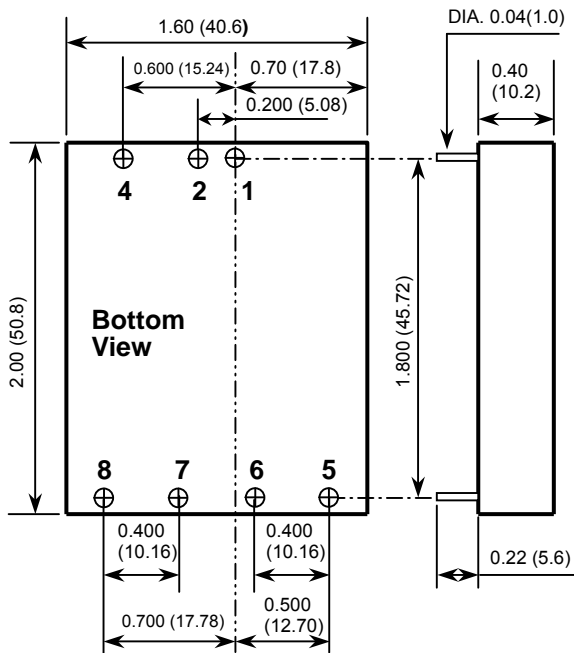

1. All dimensions in Inches (mm)  
Tolerance: X.XX±0.02 (X.X±0.5)  
X.XXX±0.01 (X.XX±0.25)
2. Pin pitch tolerance ±0.01(0.25)
3. Pin dimension tolerance ±0.004 (0.1)

PIN CONNECTION		
PIN	SINGLE	DUAL
1	+ INPUT	+ INPUT
2	- INPUT	- INPUT
4	CTRL	CTRL
5	NO PIN	+ OUTPUT
6	+ OUTPUT	COMMON
7	- OUTPUT	- OUTPUT
8	TRIM	TRIM

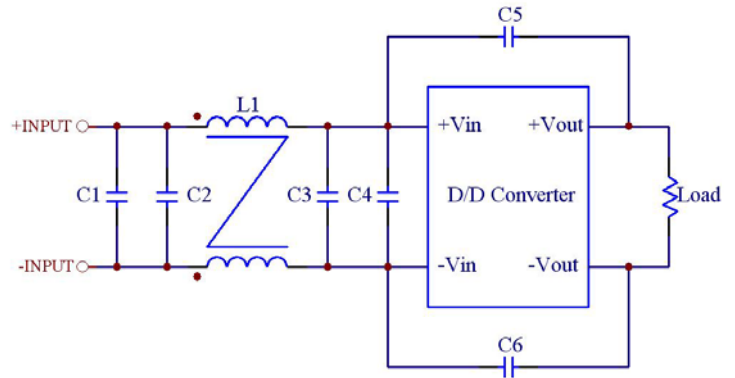
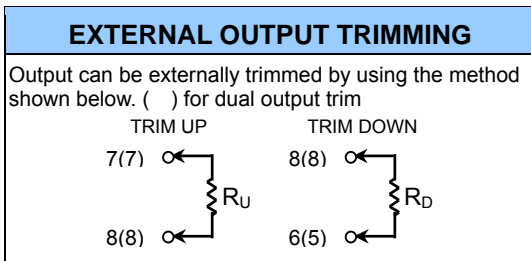

**Recommended Filter for EN55022 Class B Compliance**

The components used in the above figure, together with the manufacturers' part numbers for these components, are as follows:

	C1	C2	C3	C4	C5 & C6	L1
FEC30-12xxx	4.7µF/50V 1812 MLCC	N/A	4.7µF/50V 1812 MLCC	N/A	1000pF/2KV MLCC	450µH Common Choke PMT-048
FEC30-24xxx	6.8µF/50V 1812 MLCC	N/A	6.8µF/50V 1812 MLCC	N/A	1000pF/2KV MLCC	450µH Common Choke PMT-048
FEC30-48xxx	2.2µF/100V 1812 MLCC	2.2µF/100V 1812 MLCC	2.2µF/100V 1812 MLCC	2.2µF/100V 1812 MLCC	1000pF/2KV MLCC	450µH Common Choke PMT-048

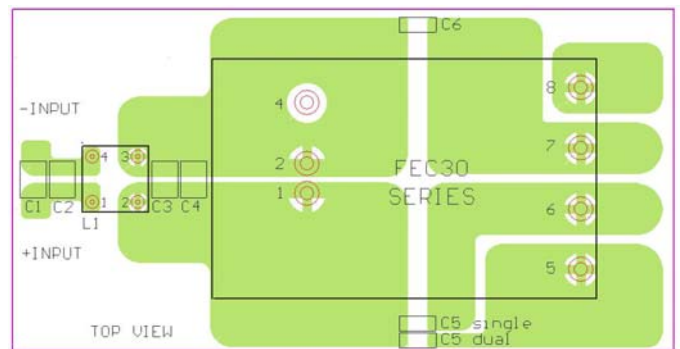

**Recommended EN55022 Class B Filter Circuit Layout**